

COMMERCIAL HEAT PUMP

Inverter Air-to-Water

*Future proof your hydronic systems
with high efficiency heat pumps with
the reliability only ATH can provide.*

- Zero-Carbon Heating
- No Greenhouse Emissions
- Environmentally Friendly
- Chilled Water Cooling

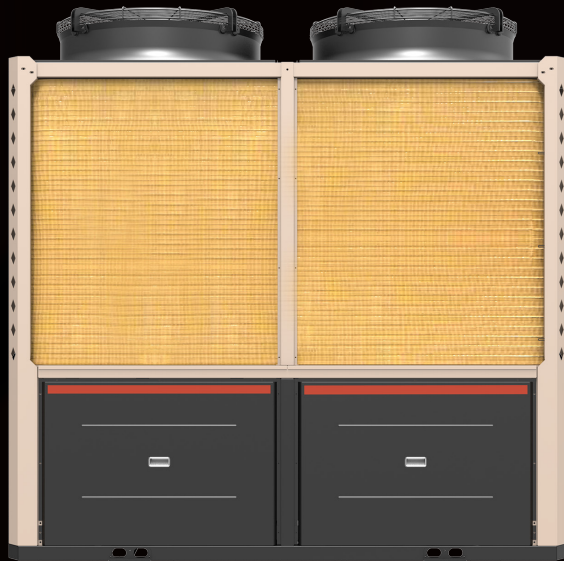

What are Air Source Heat Pumps??

When operating in heating mode, heat pumps absorb low-temperature heat from the outside air and deliver higher temperature heat to an emitter using water as the heat transfer medium. When operating in cooling mode the heat pump reverses the cycle and delivers chilled water through the same emitter.

Engineers who design commercial, industrial and institutional buildings have long understood the benefits of hydronic based systems in comparison to traditional air systems. By combining the flexibility and efficiencies of hydronic systems with the advantages of modern air-to-water heat pump technologies engineers can build high efficient heating and cooling systems quite easily.

Today's emphasis on green, environmentally friendly technologies reducing the overall carbon footprint make it imperative to think outside the box when it comes to heating and cooling applications.

ATH's new commercial air-to-water heat pumps provide building owners with engineered products built to meet tomorrow's standards, today.

Inverter Driven Compressors

Utilizing the most energy efficient technology available today, ATH uses variable speed inverter driven compressors with load matching to maximize performance efficiency in both heating (to -22°F) and cooling modes (down to 40°F). Inverter seamlessly and quietly modulates up and down based on load.

Low Ambient EVI

Enhanced Vapor Injection (EVI) technology found in our scroll compressors in conjunction with the high efficiency condenser used in ATH's heat pumps, provides improved efficiency, reliability and heating capacities, making it the perfect compressor for severe ambient conditions in colder climates, while maintaining the ability to cool during the warmer seasons.

Flexibility

Intelligent load matching touch screen control platform is easy to navigate making setting parameters a breeze. Equipment is easily zoned and have many options for types of emitters including radiant floors and ceilings, hydronic fan coils, panel radiators, low-temp fin-tube baseboard and even active chilled beams.

Environmentally Friendly

Heat pumps not only provide unsurpassed comfort, but they do it safely. Equivalent VRF systems use potentially dangerous refrigerant inside the occupied space while ATH heat pumps keep all refrigerant outside the occupied space and require no fossil fuels for energy transformation as they are all electric.

Features and Benefits

- Environmentally Friendly - Green Technology
- Inverter Compressors
- Low Ambient Performance (-20°F)
- EVI Compressor Technology
- Delivered Hot Water to 140°F
- User Friendly Touch Screen Control Platform
- No Refrigerant Handling
- Easily Piped & Zoned
- Built-in Redundancy
- BMS Compatible through Modbus

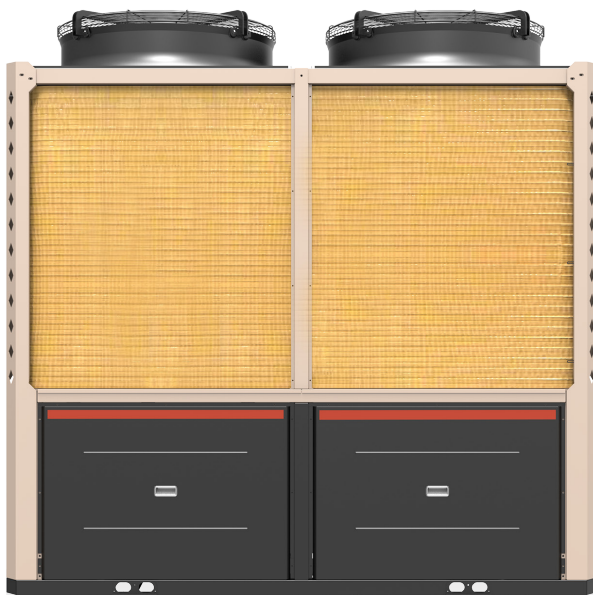

Product Overview

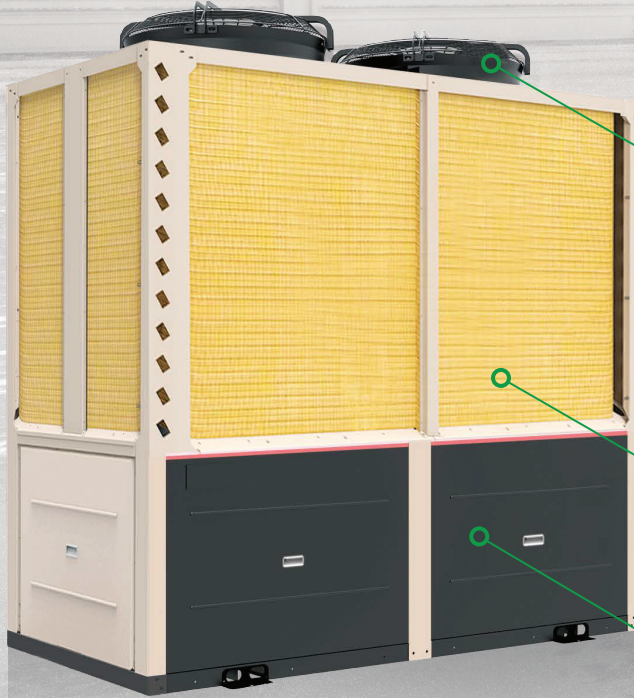

DC Motors

All units utilize external high performance DC motors that operate quietly and efficiently.

C-Fin Heat Exchangers

Finned heat exchangers can account for up to 70% of heat transfer on any coil. Our high quality corrugated fins have a directional "edged" configuration resulting in increased air turbulence for maximum heat transfer. Fins also incorporate a special anti-frost coating, increasing frost protection by up to 50% while improving COP.

Integrated Drain Pan

Unique drain pan configuration ensures any water is drained away immediately eliminating freezing and potential drain blockage.

Energy Management

Our intelligent control platform modulates based on load requirements for maximum performance efficiency throughout the operating range. Modulation also protects the equipments moving components further extending the units life cycle.

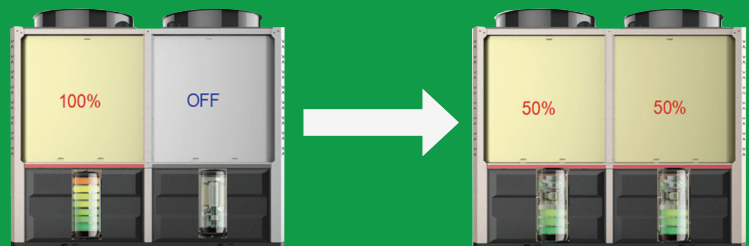

Dual Systems With Independent Air Cavity

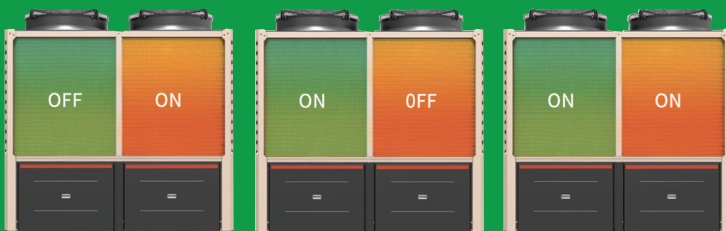

ATH's inverter heat pumps with EVI use dual independent compressor systems allowing individual operation relevant to the system demand. Individual systems also offer redundancy, where if a module is in need of maintenance the other module can still operate at its full capacity.

Commercial Heat Pump



SPECIFICATIONS

		Units	HP0275
Cooling	Capacity Range	BTU/hr	96,035-353,225
	Efficiency Range	EER	7.44-18.68
	Efficiency	IPLV	17.1
	Delivered Water Temp Range	°F	41-86
	Ambient Temp Range	°F	5-131
Heating	Capacity Range	BTU/hr	52,543-541,382
	Efficiency Range	COP	1.46-7.64
	Delivered Water Temp Range	°F	59-140
	Ambient Temp Range	°F	-22-109.4
CEC Data	Cooling Capacity*	BTU/hr	226,586
	Cooling Efficiency*	EER	8.95
	Heating Capacity**	BTU/hr	274,965
	Heating Efficiency**	COP	8.3
	Heating Capacity***	BTU/hr	187,254
	Heating Efficiency***	COP	6.2
Electrical	Power	V/Ph/Hz	460/3/60
	Fan Motor	A	4.0×2
	Compressor Motor	A	23.0×2
	MCA	A	60
	MOPD	A	70
	SCCR	kA	10
Refrigerant	Type		R410A
	Factory Charge	lbs.	19.84×2
Fan	Quantity		2
	Power Input	W	550
	Type		DC
	Max Speed	RPM	800
Sound (@3meters)	Range	dBa	54-67
Hydronic	Rated Flow	GPM	52.83
	Max Water Temp	°F	140
	Piping Connections	inch	2.5
	Rated Pressure Drop	PSI (ft W.C.)	10.15
Compressor	Type		INVERTER SCROLL
	Speed Range	Hz	30-120
	Brand		Hitachi
	Quantity		2
Dimensions	Net Dimensions (L x W x H)	inch	85.4×45.3×83.9
	Shipping Dimensions (L x W x H)	inch	86.6×52.2×88.2
	Net Weight	lbs.	1,616
	Shipping Weight	lbs.	1,709

CEC is California Energy Commission. Data is tested in accordance with AHRI 550/590

*= 44F LWT 54F EWT @10 GPM & 95F DB Ambient

**= 120F LWT 107F EWT @10 GPM & 47F DB Ambient

***= 120F LWT 110F EWT @10 GPM & 17F DB Ambient

Heating Performance

80°F Leaving Water Temperature, Heating

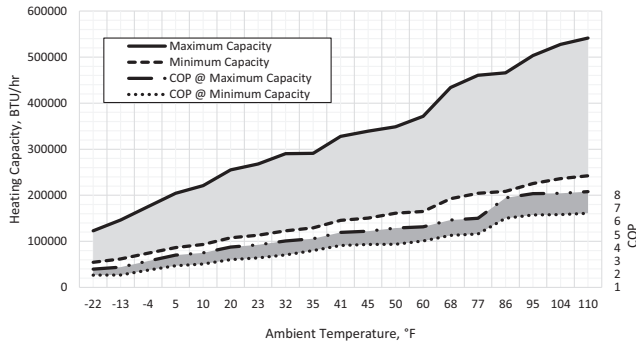

90°F Leaving Water Temperature, Heating

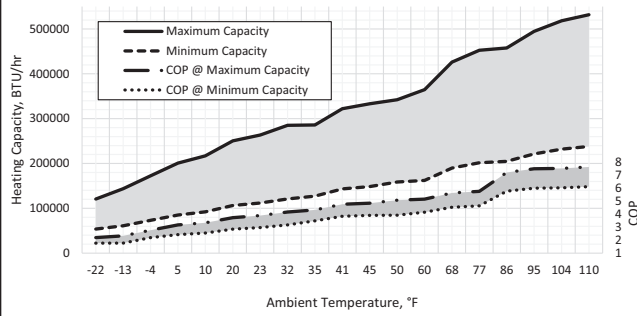

100°F Leaving Water Temperature, Heating

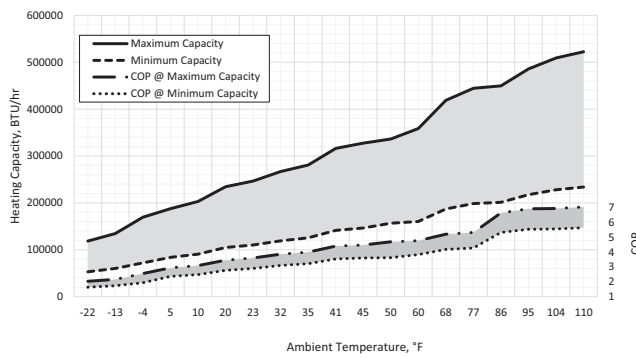

110°F Leaving Water Temperature, Heating

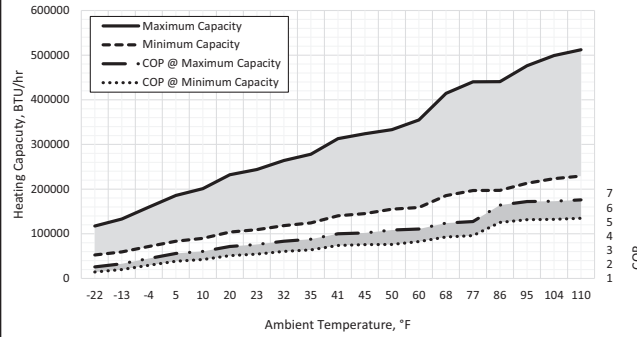

Heating Performance

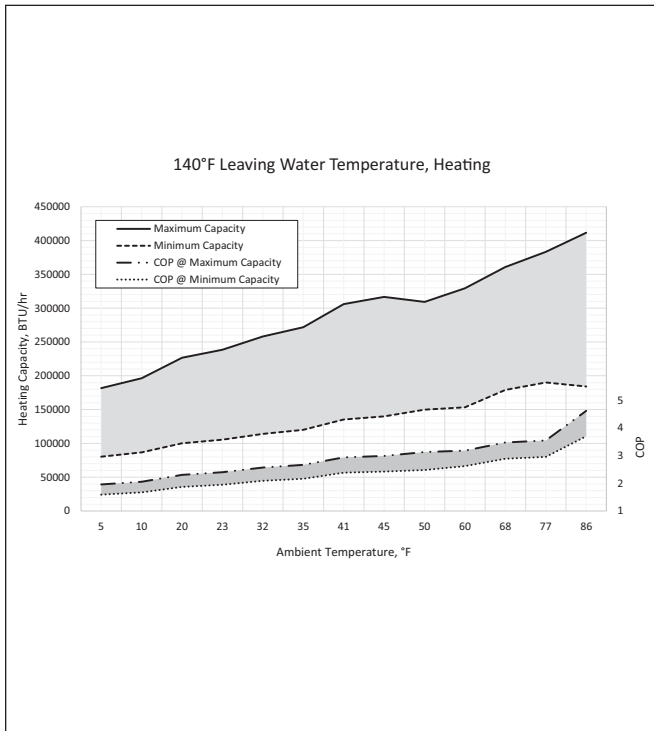
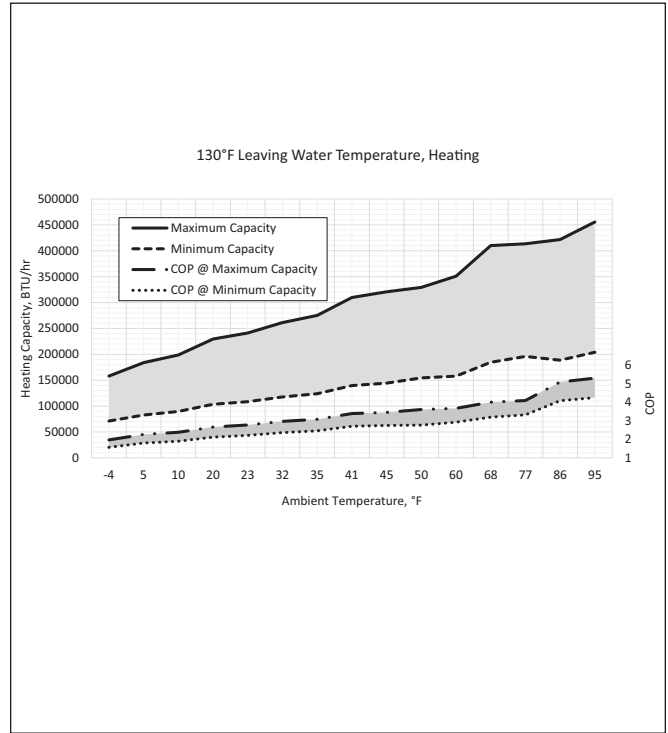
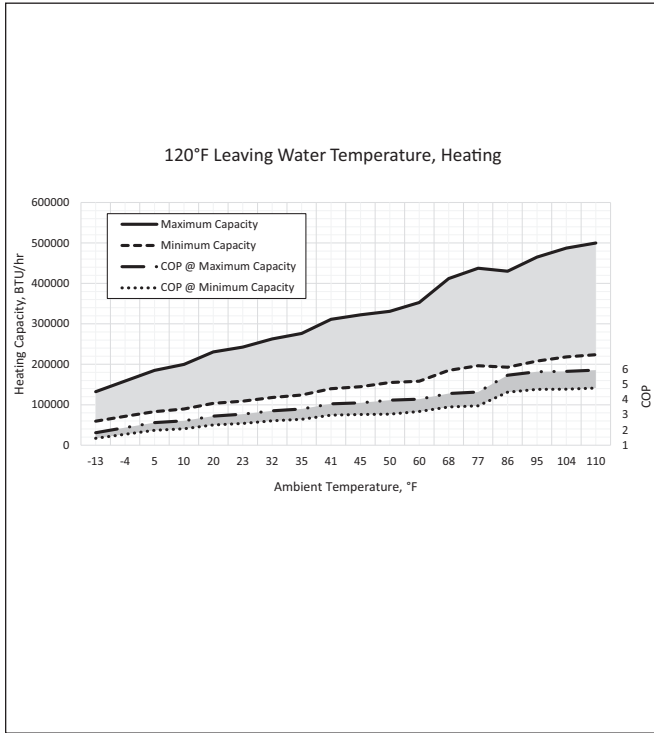

Cooling Performance

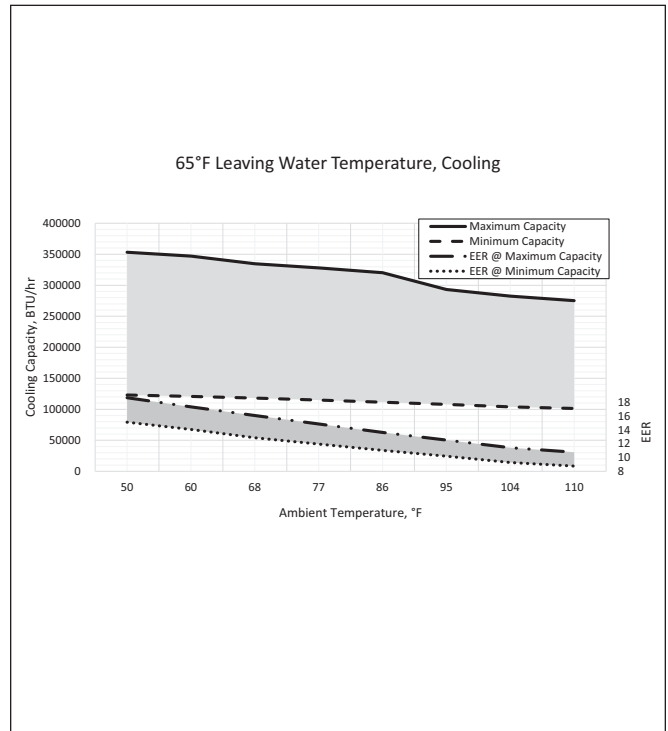
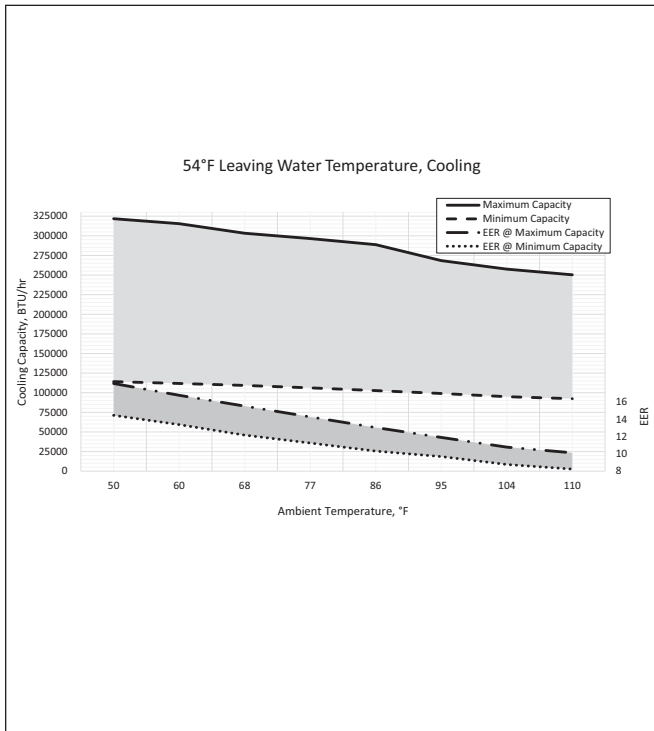
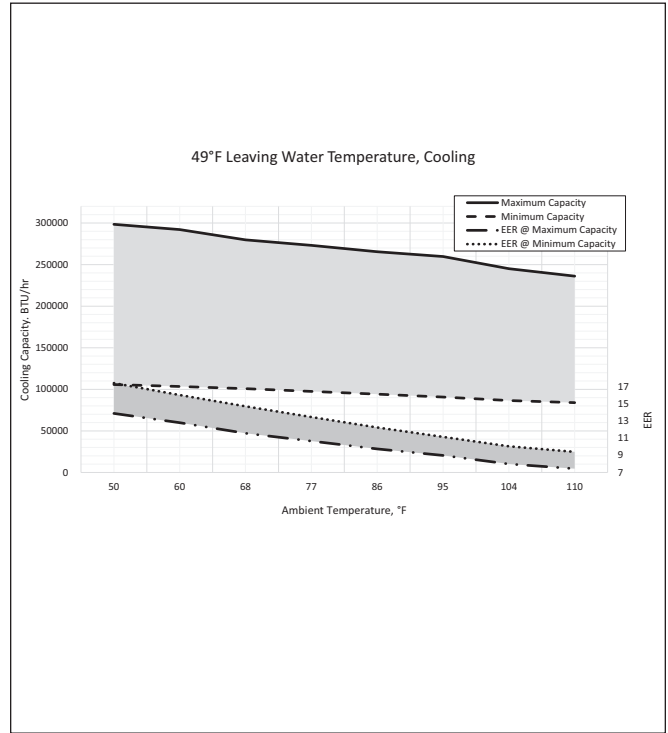
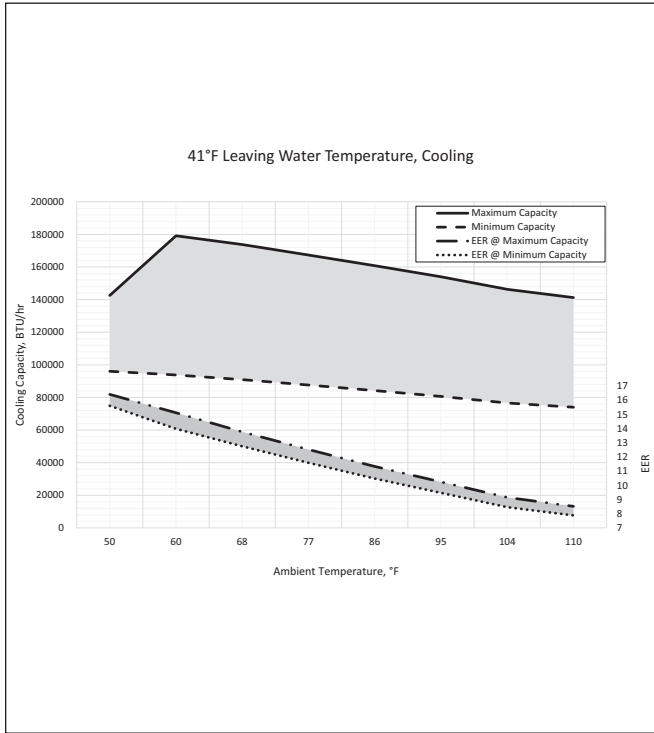

DIMENSIONS

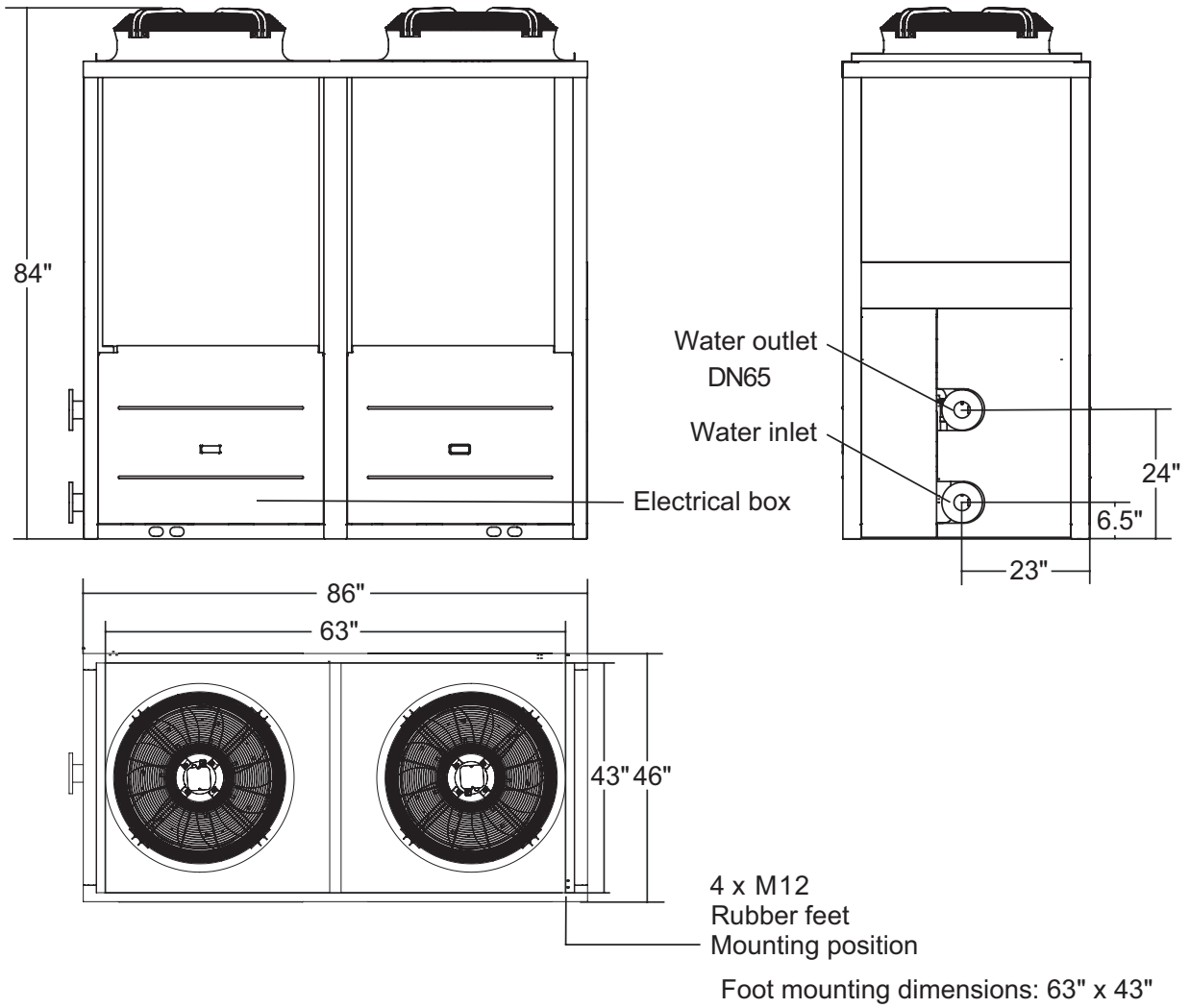

260 North Elm Street, Westfield, MA 01085

Tel. (413) 564-5515

7555 Tranmere Drive, Mississauga, Ontario L5S 1L4

Tel. (905) 670-5888

www.knseries.com